

MOTOR		
Hersteller / Modell	Cummins QSL9	
Typ	Turboaufgeladener 4-Takt-Dieselmotor mit Ladeluftkühlung	
Nennleistung am Schwungrad	SAE J1995 (brutto)	284 PS (212 kW) bei 1800 U/min
	SAE J1349 (netto)	270 PS (202 kW) bei 1800 U/min
	DIN 6271/1 (brutto)	288 PS (212 kW) bei 1800 U/min
	DIN 6271/1 (netto)	274 PS (202 kW) bei 1800 U/min
Höchstdrehmoment	123,7 kgf-m (895 lbf-ft) bei 1500 U/min	
Bohrung x Hub	114 x 145 mm (4.49" x 5.69")	
Hubraum	8900 cc (543 Kubikzoll)	
Batterien	2 x 12 V x 160 Ah	
Anlasser	Denso 24 V - 7,8 kW	
Generator	Denso 24 V - 95 A	

HYDRAULIKSYSTEM	
HAUPTPUMPE	
Typ	Variable Kolbenpumpen
Maximaler Durchfluss	2 x 277,2 l/min (73.2 U.S. gpm / 60.1 U.K. gpm)
Hilfspumpe für Vorsteuerkreis	Zahnradpumpe

Quer erfassendes und kraftstoffsparendes Pumpensystem

HYDRAULIKMOTOREN	
Fahren	Axialkolbenmotor mit zwei Geschwindigkeiten mit Bremsventil und Parkbremse
Schwenken	Axialkolbenmotor mit automatischer Bremse

ÜBERDRUCKVENTILEINSTELLUNG	
Anbaugerätekreise	350 kgf/cm ² (4980 psi)
Fahren	350 kgf/cm ² (4980 psi)
Leistungsstufe (Ausleger, Löffelstiel, Löffel)	380 kgf/cm ² (5400 psi)
Schwenkkreis	300 kgf/cm ² (4270 psi)
Vorsteuerkreis	40 kgf/cm ² (569 psi)
Serviceventil	Installiert

HYDRAULIKZYLINDER	
Zylinder: Bohrung x Hub	Ausleger: Ø 150 x 1480 mm
	Löffelstiel: Ø 160 x 1685 mm
	Tiefelöffel: Ø 140 x 1285 mm

ANTRIEBE UND BREMSSEN	
Antriebsart	Vollhydrostatisch
Antriebsmotor	Axialkolbenmotor, mit Bremse integriert
Untersetzung	Planetenuntersetzungsgetriebe
Max. Zugkraft	27000 kgf (59,500 lbf)
Max. Fahrgeschwindigkeit (Schnell-/Langsamgang)	5,9 km/h (3.67 mph) / 3,4 km/h (2.11 mph)
Steigfähigkeit	35° (70%)
Handbremse	Mehrscheibenausführung, nass

STEUERUNG	
Vorsteuerdruckunterstützte Joysticks und Pedale mit abnehmbarem Hebel für nahezu kraft- und ermüdungsfreie Bedienung.	
Vorsteuerung	Zwei Joysticks mit einem Sicherheitshebel (links): Schwenken und Löffelstiel (rechts): Ausleger und Tiefelöffel (ISO)
Fahren und Lenken	Zwei Hebel mit Pedalen
Motordrossel	Elektrisch, als Drehregler ausgeführt

SCHWENKWERK	
Schwenkmotor	Axialkolbenmotor mit festem Schluckvolumen
Schwenkuntersetzung	Planetenraduntersetzung
Drehkranzschmierung	Fettbad
Schwenkbremse	Mehrscheibenausführung, nass
Schwenkgeschwindigkeit	9,1 U/min

SERVICE-FÜLLMENGEN			
Nachfüllmenge	Liter	US gal	UK gal
Kraftstofftank	600	154.7	131.9
Motorkühlmittel	55	14.5	12.1
Motoröl	30	7.9	6.6
Schwenkeinrichtung	11	2.91	2.42
Endantrieb (je)	7,8	2.06	1.72
Hydrauliksystem (einschl. Behälter)	414	106.7	91.06
Hydraulikölbehälter	210	54.1	46.2
DEF/AdBlue®	42,5	11.2	9.3

UNTERWAGEN	
Der X-Mittelrahmen ist eine vollverschweißte Konstruktion mit verstärkten Kastenrahmen für das Laufwerk. Der Unterwagen ist mit geschmierten Rollen, Leiträdern, Kettenspannern mit stoßdämpfenden Federn und Antriebsrädern sowie Raupenkettenspannern mit 2- oder 3-Steg-Bodenplatten ausgerüstet.	
Mittelrahmen	X-Rahmen
Unterwagen	Fünfeckiges Kastenprofil
Kettenplatten pro Seite	48 je
Stützrollen pro Seite	2 je
Laufrollen pro Seite	9 je
Kettenführungen pro Seite	2 je

BETRIEBSGEWICHT (CIRCA)	
Betriebsgewicht, einschliesslich 6250 mm (20' 6") Ausleger; 3050 mm (10' 0") Löffelstiel; 1,27 m ³ (1.66 yd ³) Löffel gehäuft nach SAE, Schmiermittel, Kühlmittel, vollem Kraftstofftank, vollem Hydraulikölbehälter und aller Standardausrüstung.	

BETRIEBSGEWICHT				
Platten	Betriebsgewicht		Bodendruck	
Typ	Breite mm (in)	kg (lb)	kgf/cm ² (psi)	
Dreisteg	600 (24")	HX330 L	33500 (73,850)	0,65 (9,24)
		HX330 HW	36000 (79,370)	0,69 (9,81)
		HX330 NL	33300 (73,410)	0,64 (9,10)
	700 (28")	HX330 L	34070 (75,110)	0,56 (7,96)
		HX330 HW	36570 (80,620)	0,60 (8,53)
		HX330 L	34450 (75,950)	0,50 (7,11)
800 (32")	HX330 HW	36950 (81,460)	0,53 (7,54)	
	900 (36")	HX330 L	34830 (76,790)	0,45 (6,40)
Doppelsteg	700 (28")	HX330 L	37480 (82,630)	0,61 (8,67)

MASSE UND ARBEITSBEREICH

HX330 L

ABMESSUNGEN HX330 L / HX330 NL

Ausleger in 6,15 m (20' 2") und 6,45 m (21' 2") und Löffelstiel in 2,2 m (7' 3"); 2,5 m (8' 2"); 3,2 m (10' 6") und 4,05 m (13' 3")

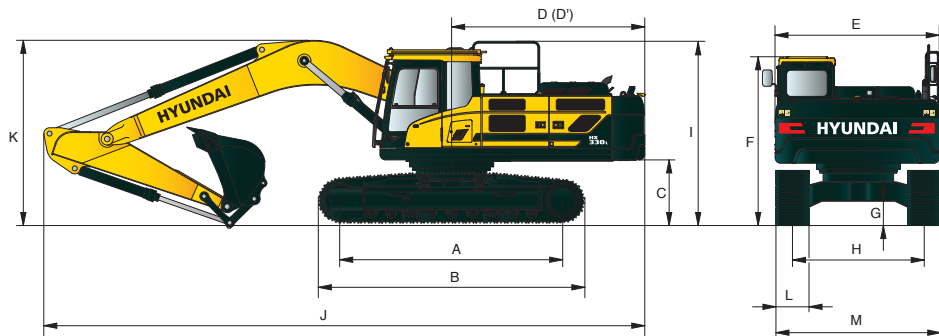

Einheit : mm (ft-in)

A	Aufstandslänge	4030 (13' 3")
B	Gesamtlänge der Raupe	4940 (16' 2")
C	Bodenfreiheit des Heckgegengewichts	1200 (3' 11")
D	Heckschwenkradius	3570 (11' 7")
D'	Hecklänge	3505 (11' 5")
E	Gesamtbreite des Oberwagens	2980 (9' 9")
F	Gesamthöhe der Kabine	3160 (10' 4")
G	Mindest-Bodenfreiheit	500 (1' 8")
H	Spurweite	HX330 L 2680 (8' 10") HX330 NL 2390 (7' 10")
I	Gesamthöhe des Schutzgeländers	3350 (11' 0")

Auslegerlänge	6150 (20' 2")	6450 (21' 2")			
Löffelstiellänge	2200 (7' 3")	2200 (7' 3")	2500 (8' 2")	3200 (10' 6")	4050 (13' 3")
J Gesamtlänge	11170 (36' 8")	11470 (37' 8")	11340 (37' 2")	11220 (36' 10")	11220 (36' 10")
K Gesamthöhe des Auslegers	3680 (12' 1")	3740 (11' 11")	3760 (12' 0")	3380 (11' 1")	3860 (12' 8")
L Breite der Bodenplatten	600 (24")	700 (28")	800 (32")	900 (36")	
M Gesamtbreite	HX330 L 3280 (10' 9") HX330 NL 2990 (9' 10")	3380 (11' 1")	3480 (11' 5")	3580 (11' 5")	

ARBEITSBEREICH HX330 L / HX330 NL

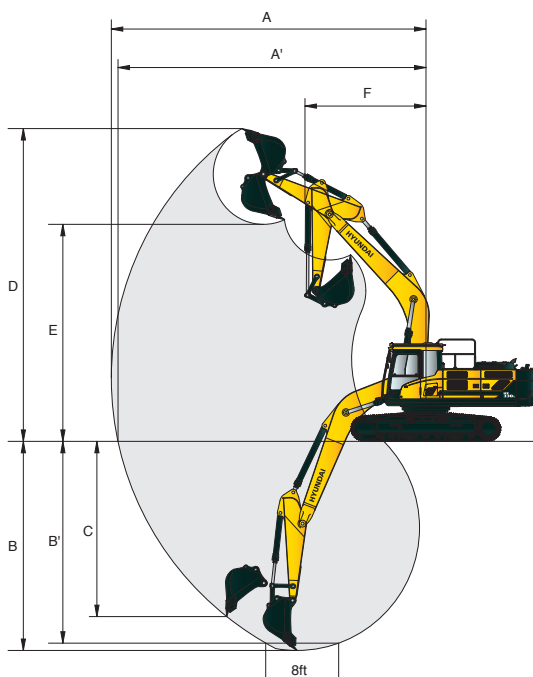

Einheit : mm (ft-in)

Auslegerlänge	6150 (20' 2")	6450 (21' 2")			
Löffelstiellänge	2200 (7' 3")	2200 (7' 3")	2500 (8' 2")	3200 (10' 6")	4050 (13' 3")
A Max. Schachtweite	10020 (32' 10")	10330 (33' 11")	10550 (34' 7")	11140 (36' 7")	11950 (39' 2")
A' Max. Schachtweite am Boden	9800 (32' 2")	10110 (33' 2")	10330 (33' 11")	10940 (35' 11")	11760 (38' 7")
B Max. Schachttiefe	6160 (20' 3")	6370 (20' 11")	6670 (21' 11")	7370 (24' 2")	8220 (26' 12")
B' Max. Schachttiefe (auf ca. 2,40 m)	5950 (19' 6")	6160 (20' 3")	6470 (21' 3")	7210 (23' 8")	8080 (26' 6")
C Max. vertikale Abstechtiefe	5710 (18' 9")	5980 (19' 7")	5920 (19' 5")	6360 (20' 10")	7260 (23' 10")
D Max. Einstechhöhe	9940 (32' 7")	10220 (33' 6")	10170 (33' 4")	10310 (33' 10")	10710 (35' 2")
E Max. Ladehöhe	6780 (22' 3")	7050 (23' 2")	7050 (23' 2")	7240 (23' 9")	7630 (25' 0")
F Min. Frontschwenkradius	4520 (14' 10")	4700 (15' 5")	4550 (14' 11")	4460 (14' 8")	4470 (14' 8")

MASSE UND ARBEITSBEREICH

HX330 L

ABMESSUNGEN HX330 L HIGH WALKER

Ausleger in 6,45 m (21' 2") und Löffelstiel in 2,2 m (7' 3"); 2,5 m (8' 2"); 3,2 m (10' 6") und 4,05 m (13' 3")

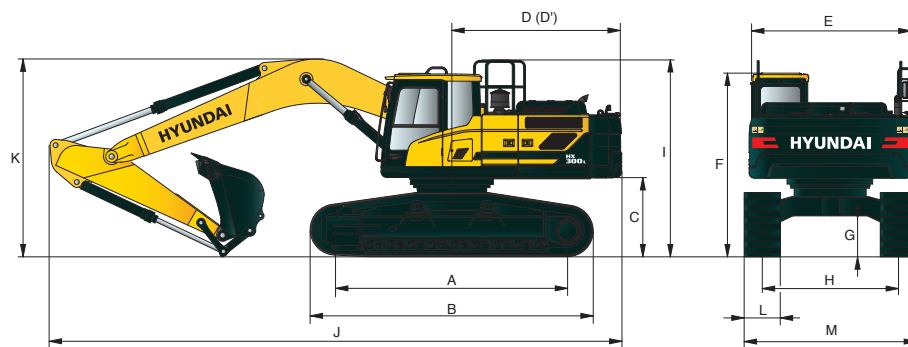

Einheit : mm (ft-in)

A	Aufstandslänge	4030 (13' 3")
B	Gesamtlänge der Raupe	4940 (16' 2")
C	Bodenfreiheit des Heckgegengewichts	1500 (4' 11")
D	Heckschwenkradius	3570 (11' 7")
D'	Hecklänge	3505 (11' 5")
E	Gesamtbreite des Oberwagens	2980 (9' 9")
F	Gesamthöhe der Kabine	3440 (11' 3")
G	Mindest-Bodenfreiheit	765 (2' 6")
H	Spurweite	2870 (9' 5")
I	Gesamthöhe des Schutzgelanders	3650 (12' 0")



Auslegerlänge	6450 (21' 2")				
Löffelstiellänge	2200 (7' 3")	2500 (8' 2")	3200 (10' 6")	4050 (13' 3")	
J Gesamtlänge	11460 (37' 7")	11340 (37' 2")	11150 (36' 7")	11240 (36' 11")	
K Gesamthöhe des Auslegers	3740 (12' 3")	3760 (12' 4")	3360 (11' 0")	3810 (12' 6")	
L Bodenplatten	Typ	Dreisteg		Doppelsteg	
	Breite	600 (24")	700 (28")	800 (32")	900 (36")
M Gesamtbreite		3470 (11' 5")	3570 (11' 9")	3670 (12' 0")	3570 (11' 9")

ARBEITSBEREICH HX330 L HIGH WALKER

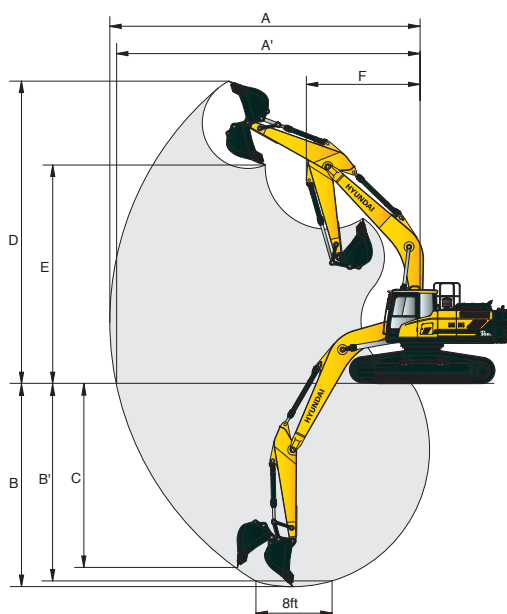
Einheit : mm (ft-in)













Auslegerlänge	6450 (21' 2")			
Löffelstiellänge	2200 (7' 3")	2500 (8' 2")	3200 (10' 6")	4050 (13' 3")
A Max. Schachtweite	10330 (33' 11")	10550 (34' 7")	11140 (36' 7")	11950 (39' 2")
A' Max. Schachtweite am Boden	10040 (32' 11")	10270 (33' 8")	10880 (35' 8")	11710 (38' 5")
B Max. Schachttiefe	6100 (20' 0")	6400 (20' 12")	7100 (23' 4")	7950 (26' 1")
B' Max. Schachttiefe (auf ca. 2,40 m)	5890 (19' 4")	6200 (20' 4")	6940 (22' 9")	7800 (25' 7")
C Max. vertikale Abstechtiefe	5700 (18' 8")	5650 (18' 6")	6080 (19' 11")	6980 (22' 11")
D Max. Einstechhöhe	10500 (34' 5")	10450 (34' 3")	10590 (34' 9")	10990 (36' 1")
E Max. Ladehöhe	7330 (24' 1")	7330 (24' 1")	7520 (24' 8")	7910 (25' 11")
F Min. Frontschwenkradius	4700 (15' 5")	4550 (14' 11")	4460 (14' 8")	4470 (14' 8")











 Lastradius Frontauslage  Lastradius Seitenauslage bzw. 360 Grad

HX330 L

6,15 m (20' 2") Ausleger; 2,2 m (7' 3") Löffelstiel; 1,44 m³ Löffel (nach SAE gehäuft); 600 mm (24") 3-Steg-Bodenplatten



Lasthöhe m (ft)	Lastradius								Max. Reichweite			
	3.0 m (9.8 ft)		4.5 m (14.7 ft)		6.0 m (19.6 ft)		7.5 m (24.5 ft)		Volumen		Reichweite m (ft)	
												
7.5 m (25 ft)	kg									*7380	6080	7.69
	lb									*16270	13400	(25.2)
6.0 m (20 ft)	kg				*8280	*8280	*7970	6200	*7440	4850		8.61
	lb				*18250	*18250	*17570	13670	*16400	10690		(28.2)
4.5 m (15 ft)	kg		*11980	*11980	*9530	8850	*8390	6060	6600	4230		9.16
	lb		*26410	*26410	*21010	19510	*18500	13360	14550	9330		(30.1)
3.0 m (10 ft)	kg		*15470	13010	*11120	8350	9080	5830	6220	3950		9.39
	lb		*34110	28680	*24520	18410	20020	12850	13710	8710		(30.8)
1.5 m (5 ft)	kg		*17910	12210	*12530	7920	8840	5600	6190	3910		9.35
	lb		*39480	26920	*27620	17460	19490	12350	13650	8620		(30.7)
Boden- niveau	kg		*18640	11930	12410	7660	8670	5450	6530	4120		9.02
	lb		*41090	26300	27360	16890	19110	12020	14400	9080		(29.6)
-1.5 m (-5 ft)	kg	*16990	*16990	*18160	11930	12320	7580	8630	5420	7400	4690	8.37
	lb	*37460	*37460	*40040	26300	27160	16710	19030	11950	16310	10340	(27.5)
-3.0 m (-10 ft)	kg	*22830	*22830	*16550	12120	*12300	7690			*8260	5970	7.29
	lb	*50330	*50330	*36490	26720	*27120	16950			*18210	13160	(23.9)
-4.5 m (-15 ft)	kg	*17800	*17800	*13080	12560							
	lb	*39240	*39240	*28840	27690							

6,45 m (21' 2") Ausleger; 2,2 m (7' 3") Löffelstiel; 1,44 m³ Löffel (nach SAE gehäuft); 600 mm (24") 3-Steg-Bodenplatten

Lasthöhe m (ft)	Lastradius								Max. Reichweite			
	3.0 m (9.8 ft)		4.5 m (14.7 ft)		6.0 m (19.6 ft)		7.5 m (24.5 ft)		Volumen		Reichweite m (ft)	
												
7.5 m (25 ft)	kg									*7020	5490	8.07
	lb									*15480	12100	(26.5)
6.0 m (20 ft)	kg					*8120	*8120	*7600	6140	6900	4430	8.95
	lb					*17900	*17900	*16760	13540	15210	9770	(29.4)
4.5 m (15 ft)	kg			*12260	*12260	*9450	8660	*8150	5950	6140	3890	9.47
	lb			*27030	*27030	*20830	19090	*17970	13120	13540	8580	(31.1)
3.0 m (10 ft)	kg					*11050	8120	8930	5690	5790	3630	9.70
	lb					*24360	17900	19690	12540	12760	8000	(31.8)
1.5 m (5 ft)	kg					*12410	7680	8670	5450	5770	3600	9.66
	lb					*27360	16930	19110	12020	12720	7940	(31.7)
Boden- niveau	kg			*18350	11600	12150	7430	8500	5290	6060	3780	9.34
	lb			*40450	25570	26790	16380	18740	11660	13360	8330	(30.6)
-1.5 m (-5 ft)	kg	*14500	*14500	*17770	11640	12080	7370	8460	5250	6810	4280	8.72
	lb	*31970	*31970	*39180	25660	26630	16250	18650	11570	15010	9440	(28.6)
-3.0 m (-10 ft)	kg	*22000	*22000	*16270	11850	12210	7480			*7830	5360	7.70
	lb	*48500	*48500	*35870	26120	26920	16490			*17260	11820	(25.3)
-4.5 m (-15 ft)	kg	*17710	*17710	*13290	12270							
	lb	*39040	*39040	*29300	27050							













1. Die Hublast richtet sich nach der Definition in SAE J1097 und ISO 10567.
2. Die Hublast der Serie ROBEX darf auf festem, ebenem Untergrund maximal 75 % der Kippplast der Maschine bzw. 87 % der gesamten hydraulischen Hubkraft betragen.

3. Der Lasthaken befindet sich an der Rückseite des Tieflöffels.
4. (*) gibt die Lastbegrenzung durch die hydraulische Hubkraft an.













 Lastradius Frontauslage  Lastradius Seitenauslage bzw. 360 Grad

HX330 L

6,45 m (21' 2") Ausleger; 2,5 m (8' 2") Löffelstiel; 1,44 m³ Löffel (nach SAE gehäuft); 600 mm (24") 3-Steg-Bodenplatten

Lasthöhe m (ft)	Lastradius										Max. Reichweite		
	3.0 m (9.8 ft)		4.5 m (14.7 ft)		6.0 m (19.6 ft)		7.5 m (24.5 ft)		9.0 m (29.4 ft)		Volumen	Reichweite	
													m (ft)
7.5 m (24.5 ft)	kg										*6610	5190	8.34
	lb										*14570	11440	(27.4)
6.0 m (19.6 ft)	kg						*7220	6170			6590	4220	9.19
	lb						*15920	13600			14530	9300	(30.2)
4.5 m (14.7 ft)	kg		*11490	*11490	*9010	8710	*7820	5960			5880	3710	9.70
	lb		*25330	*25330	*19860	19200	*17240	13140			12960	8180	(31.8)
3.0 m (9.8 ft)	kg		*15000	12650	*10650	8130	*8660	5670			5560	3460	9.92
	lb		*33070	27890	*23480	17920	*19090	12500			12260	7630	(32.5)
1.5 m (4.9 ft)	kg		*17450	11780	*12090	7650	8640	5410	6410	3990	5520	3420	9.88
	lb		*38470	25970	*26650	16870	19050	11930	14130	8800	12170	7540	(32.4)
Boden-niveau	kg		*18220	11490	12090	7360	8440	5230			5780	3580	9.57
	lb		*40170	25330	26650	16230	18610	11530			12740	7890	(31.4)
-1.5 m (-4.9 ft)	kg	*15100	*15100	*17870	11480	11980	7270	8370	5170		6450	4020	8.97
	lb	*33290	*33290	*39400	25310	26410	16030	18450	11400		14220	8860	(29.4)
-3.0 m (-9.8 ft)	kg	*22890	*22890	*16580	11660	12070	7350				*7820	4960	7.98
	lb	*50460	*50460	*36550	25710	26610	16200				*17240	10930	(26.2)
-4.5 m (-14.7 ft)	kg	*18960	*18960	*13950	12050	*10230	7640				*7180	*7180	6.42
	lb	*41800	*41800	*41800	26570	*22550	16840				*15830	*15830	(21.1)

6,45 m (21' 2") Ausleger; 3,2 m (10' 6") Löffelstiel; 1,44 m³ Löffel (nach SAE gehäuft); 600 mm (24") 3-Steg-Bodenplatten

Lasthöhe m (ft)	Lastradius										Max. Reichweite				
	1.5 m (5 ft)		3.0 m (10 ft)		4.5 m (15 ft)		6.0 m (20 ft)		7.5 m (25 ft)		9.0 m (30 ft)		Volumen	Reichweite	
													m (ft)		
7.5 m (25 ft)	kg							*5160	*5160				*5870	4510	9.06
	lb							*11380	*11380				*12940	9940	(29.7)
6.0 m (20 ft)	kg							*6410	6300				5880	3740	9.84
	lb							*14130	13890				12960	8250	(32.3)
4.5 m (15 ft)	kg						*8000	*8000	*7090	6040	*5360	4290	5300	3310	10.31
	lb						*17640	*17640	*15630	13320	*11820	9460	11680	7300	(33.8)
3.0 m (10 ft)	kg			*13300	13080	*9720	8270	*8020	5730	6570	4140	5020	3090	10.52	
	lb			*29320	28840	*21430	18230	*17680	12630	14480	9130	11070	6810	(34.5)	
1.5 m (5 ft)	kg			*16290	11990	*11360	7720	8650	5420	6390	3970	4970	3040	10.48	
	lb			*35910	26430	*25040	17020	19070	11950	14090	8750	10960	6700	(34.4)	
Boden-niveau	kg		*10320	*10320	*17800	11460	12070	7340	8400	5190	6260	3850	5160	3150	10.19
	lb		*22750	*22750	*39240	25260	26610	16180	18520	11440	13800	8490	11380	6940	(33.4)
-1.5 m (-5 ft)	kg	*11460	*11460	*14560	*14560	*18040	11320	11870	7160	8260	5060		5660	3470	9.63
	lb	*25260	*25260	*32100	*32100	*39770	24960	26170	15790	18210	11160		12480	7650	(31.6)
-3.0 m (-10 ft)	kg	*15430	*15430	*19550	*19550	*17260	11400	11870	7160	8270	5070		6690	4160	8.74
	lb	*34020	*34020	*43100	*43100	*38050	25130	26170	15790	18230	11180		14750	9170	(28.7)
-4.5 m (-15 ft)	kg			*21700	*21700	*15310	11680	*11330	7350				*7380	5670	7.37
	lb			*47840	*47840	*33750	25750	*24980	16200				*16270	12500	(24.2)
-6.0 m (-20 ft)	kg					*11240	*11240								
	lb					*24780	*24780								















- Die Hublast richtet sich nach der Definition in SAE J1097 und ISO 10567.
- Die Hublast der Serie ROBEX darf auf festem, ebenem Untergrund maximal 75 % der Kippplast der Maschine bzw. 87 % der gesamten hydraulischen Hubkraft betragen.

- Der Lasthaken befindet sich an der Rückseite des Tieflöffels.
- (*) gibt die Lastbegrenzung durch die hydraulische Hubkraft an.

 Lastradius Frontauslage  Lastradius Seitenauslage bzw. 360 Grad











HX330 L

6,45 m (21' 2") Ausleger; 4,05 m (13' 3") Löffelstiel; 1,44 m³ Löffel (nach SAE gehäuft); 600 mm (24") 3-Steg-Bodenplatten

Lasthöhe m (ft)	Lastradius										Max. Reichweite					
	1.5 m (5.0 ft)		3.0 m (10.0 ft)		4.5 m (15.0 ft)		6.0 m (20.0 ft)		7.5 m (25.0 ft)		9.0 m (30.0 ft)		Volumen	Reichweite		
															m (ft)	
7.5 m (25 ft)	kg												*5090	3700	10.00	
	lb												*11220	8160	(32.8)	
6.0 m (20 ft)	kg											*4410	*4410	5020	3120	10.71
	lb											*9720	*9720	11070	6880	(35.1)
4.5 m (15 ft)	kg							*6100	*6100	*5630	4330	4570	2780			11.13
	lb							*13450	*13450	*12410	9550	10080	6130			(36.5)
3.0 m (10 ft)	kg		*17980	*17980	*11050	*11050	*8430	*8430	*7110	5780	*6360	4130	4340	2600		11.32
	lb		*39640	*39640	*24360	*24360	*18580	*18580	*15670	12740	*14020	9110	9570	5730		(37.1)
1.5 m (5 ft)	kg		*10550	*10550	*14520	12330	*10270	7820	*8170	5420	6360	3930	4290	2540		11.29
	lb		*23260	*23260	*32010	27180	*22640	17240	*18010	11950	14020	8660	9460	5600		(37.0)
Boden- niveau	kg		*10920	*10920	*16810	11520	*11740	7330	8350	5130	6170	3750	4420	2620		11.03
	lb		*24070	*24070	*37060	25400	*25880	16160	18410	11310	13600	8270	9740	5780		(36.2)
-1.5 m (-5 ft)	kg	*9970	*9970	*13500	*13500	*17770	11160	11760	7050	8140	4940	6050	3650	4780	2850	10.52
	lb	*21980	*21980	*29760	*29760	*39180	24600	25930	15540	17950	10890	13340	8050	10540	6280	(34.5)
-3.0 m (-10 ft)	kg	*13140	*13140	*17090	*17090	*17640	11100	11650	6950	8060	4870	6040	3640	5480	3320	9.72
	lb	*28970	*28970	*37680	*37680	*38890	24470	25680	15320	17770	10740	13320	8020	12080	7320	(31.9)
-4.5 m (-15 ft)	kg	*16780	*16780	*21910	*21910	*16430	11260	11730	7030	8150	4950			*6870	4260	8.53
	lb	*36990	*36990	*48300	*48300	*36220	24820	25860	15500	17970	10910			*15150	9390	(28.0)
-6.0 m (-20 ft)	kg		*19740	*19740	*13170	11670	*9910	7320						*6610	6600	6.71
	lb		*43520	*43520	*30230	25730	*21850	16140						*14570	14550	(22.0)



HX330 NL

6,45 m (21' 2") Ausleger; 2,2 m (7' 3") Löffelstiel; 1,44 m³ Löffel (nach SAE gehäuft); 600 mm (24") 3-Steg-Bodenplatten

Lasthöhe m (ft)	Lastradius								Max. Reichweite			
	3.0 m (9.8 ft)		4.5 m (14.7 ft)		6.0 m (19.6 ft)		7.5 m (24.5 ft)		Volumen	Reichweite		
											m (ft)	
7.5 m (25 ft)	kg									*7020	4640	8.07
	lb									*15480	10230	(26.5)
6.0 m (20 ft)	kg					*8120	7760	*7600	5180	6850	3700	8.95
	lb					*17900	17110	*16760	11420	15100	8160	(29.4)
4.5 m (15 ft)	kg			*12260	11550	*9450	7310	*8150	5000	6090	3210	9.47
	lb			*27030	25460	*20830	16120	*17970	11020	13430	7080	(31.1)
3.0 m (10 ft)	kg					*11050	6790	8880	4750	5750	2980	9.70
	lb					*24360	14970	19580	10470	12680	6570	(31.8)
1.5 m (5 ft)	kg					12360	6360	8620	4520	5730	2940	9.66
	lb					27250	14020	19000	9960	12630	6480	(31.7)
Boden- niveau	kg		*18350	9450	12070	6130	8440	4370	6020	3100	9.34	
	lb		*40450	20830	26610	13510	18610	9630	13270	6830	(30.6)	
-1.5 m (-5 ft)	kg	*14500	*14500	*17770	9500	12010	6070	8400	4330	6770	3530	8.72
	lb	*31970	*31970	*39180	20940	26480	13380	18520	9550	14930	7780	(28.6)
-3.0 m (-10 ft)	kg	*22000	19730	*16270	9690	12130	6170			*7830	4460	7.70
	lb	*48500	43500	*35870	21360	26740	13600			*17260	9830	(25.3)
-4.5 m (-15 ft)	kg	*17710	*17710	*13290	10090							
	lb	*39040	*39040	*29300	22240							













1. Die Hublast richtet sich nach der Definition in SAE J1097 und ISO 10567.
2. Die Hublast der Serie ROBEX darf auf festem, ebenem Untergrund maximal 75 % der Kippplast der Maschine bzw. 87 % der gesamten hydraulischen Hubkraft betragen.

3. Der Lasthaken befindet sich an der Rückseite des Tieflöffels.
4. (*) gibt die Lastbegrenzung durch die hydraulische Hubkraft an.















 Lastradius Frontauslage  Lastradius Seitenauslage bzw. 360 Grad

HX330 NL

6,45 m (21' 2") Ausleger; 2,5 m (8' 2") Löffelstiel; 1,44 m³ Löffel (nach SAE gehäuft); 600 mm (24") 3-Steg-Bodenplatten

Lasthöhe m (ft)	Lastradius										Max. Reichweite			
	3.0 m (9.8 ft)		4.5 m (14.7 ft)		6.0 m (19.6 ft)		7.5 m (24.5 ft)		9.0 m (29.4 ft)		Volumen	Reichweite		
													m (ft)	
7.5 m (24.5 ft)	kg											*6610	4380	8.34
	lb											*14570	9660	(27.4)
6.0 m (19.6 ft)	kg						*7220	5210				6550	3510	9.19
	lb						*15920	11490				14440	7740	(30.2)
4.5 m (14.7 ft)	kg		*11490	*11490	*9010	7350	*7820	5010				5840	3050	9.70
	lb		*25330	*25330	*19860	16200	*17240	11050				12870	6720	(31.8)
3.0 m (9.8 ft)	kg		*15000	10440	*10650	6800	*8660	4730				5520	2830	9.92
	lb		*33070	23020	*23480	14990	*19090	10430				12170	6240	(32.5)
1.5 m (4.9 ft)	kg		*17450	9620	*12090	6340	8580	4480	6360	3270		5480	2780	9.88
	lb		*38470	21210	*26650	13980	18920	9880	14020	7210		12080	6130	(32.4)
Boden-niveau	kg		*18220	9340	12010	6060	8380	4300				5740	2920	9.57
	lb		*40170	20590	26480	13360	18470	9480				12650	6440	(31.4)
-1.5 m (-4.9 ft)	kg	*15100	*15100	*17870	9340	11900	5970	8310	4240			6400	3290	8.97
	lb	*33290	*33290	*39400	20590	26230	13160	18320	9350			14110	7250	(29.4)
-3.0 m (-9.8 ft)	kg	*22890	19360	*16580	9510	11990	6040					*7820	4110	7.98
	lb	*50460	42680	*36550	20970	26430	13320					*17240	9060	(26.2)
-4.5 m (-14.7 ft)	kg	*18960	*18960	*13950	9870	*10230	6330					*7180	6120	6.42
	lb	*41800	*41800	*30750	21760	*22550	13960					*15830	13490	(21.1)

6,45 m (21' 2") Ausleger; 3,2 m (10' 6") Löffelstiel; 1,44 m³ Löffel (nach SAE gehäuft); 600 mm (24") 3-Steg-Bodenplatten

Lasthöhe m (ft)	Lastradius										Max. Reichweite					
	1.5 m (5 ft)		3.0 m (10 ft)		4.5 m (15 ft)		6.0 m (20 ft)		7.5 m (25 ft)		9.0 m (30 ft)		Volumen	Reichweite		
															m (ft)	
7.5 m (25 ft)	kg								*5160	*5160			*5870	3780	9.06	
	lb								*11380	*11380			*12940	8330	(29.7)	
6.0 m (20 ft)	kg								*6410	5340			5840	3090	9.84	
	lb								*14130	11770			12870	6810	(32.3)	
4.5 m (15 ft)	kg					*8000	7520	*7090	5090			*5360	3570	5260	2700	10.31
	lb					*17640	16580	*15630	11220			*11820	7870	11600	5950	(33.8)
3.0 m (10 ft)	kg			*13300	10840	*9720	6930	*8020	4780	6530	3410	4980	2500	10.52		
	lb			*29320	23900	*21430	15280	*17680	10540	14400	7520	10980	5510	(34.5)		
1.5 m (5 ft)	kg			*16290	9820	*11360	6400	8600	4480	6350	3250	4930	2450	10.48		
	lb			*35910	21650	*25040	14110	18960	9880	14000	7170	10870	5400	(34.4)		
Boden-niveau	kg		*10320	*10320	*17800	9320	11990	6030	8340	4260	6220	3130	5120	2540	10.19	
	lb		*22750	*22750	*39240	20550	26430	13290	18390	9390	13710	6900	11290	5600	(33.4)	
-1.5 m (-5 ft)	kg	*11460	*11460	*14560	*14560	*18040	9180	11790	5860	8210	4140		5620	2820	9.63	
	lb	*25260	*25260	*32100	*32100	*39770	20240	25990	12920	18100	9130		12390	6220	(31.6)	
-3.0 m (-10 ft)	kg	*15430	*15430	*19550	18810	*17260	9260	11790	5860	8220	4150		6640	3410	8.74	
	lb	*34020	*34020	*43100	41470	*38050	20410	25990	12920	18120	9150		14640	7520	(28.7)	
-4.5 m (-15 ft)	kg		*21700	19340	*15310	9520	*11330	6040					*7380	4710	7.37	
	lb		*47840	42640	*33750	20990	*24980	13320					*16270	10380	(24.2)	
-6.0 m (-20 ft)	kg			*11240	10070											
	lb			*24780	22200											

- Die Hublast richtet sich nach der Definition in SAE J1097 und ISO 10567.
- Die Hublast der Serie ROBEX darf auf festem, ebenem Untergrund maximal 75 % der Kipplast der Maschine bzw. 87 % der gesamten hydraulischen Hubkraft betragen.

- Der Lasthaken befindet sich an der Rückseite des Tieflöffels.
- (*) gibt die Lastbegrenzung durch die hydraulische Hubkraft an.

MOTOR	STD	OPT
Cummins-Motor QSL 9	●	
HYDRAULIKSYSTEM		
IPC (Intelligent Power Control)		
3 Leistungsstufen, 2 Arbeitsarten, Benutzermodus	●	
Variable Leistungssteuerung	●	
Pumpenfördermengenregelung	●	
Volumenstromregelung für Anbaugerät-Betriebsart		●
Automatischer Motorleerlauf	●	
Automatische Motorabschaltung		●
Elektronische Gebläsesteuerung	●	
KABINE UND INNENRAUM		
Kabine nach ISO-Norm		
Obenrunder Frontscheibenwischer	●	
Radio/USB-Player	●	
Mobiltelefon-Freisprecheinrichtung mit USB	●	
12-Volt-Steckdose (Wandler 24 VDC auf 12 VDC)	●	
Elektrisches Signalhorn	●	
Allwetter-Stahlkabine mit 360°-Rundsicht	●	
Sicherheitsglasscheiben	●	
Frontscheibe einschiebbar	●	
Seitenscheibe (links) als Schiebefenster	●	
Abschließbare Tür	●	
Warmhalte- und Kühlbox	●	
Aufbewahrungsfach und Aschenbecher	●	
Kabinendachabdeckung transparent	●	
Sonnenblende	●	
Tür- und Kabinenschlösser, ein Schlüssel	●	
Mechanisch gefederter, beheizter Sitz	●	
Vorsteuerdruckunterstützter Joystick	●	
Konsole höhenverstellbar	●	
Automatische Klimaregelung		
Klimaanlage und Heizung	●	
Scheibenheizung	●	
Starthilfe (Ansaugluftvorwärmung) bei kalten Temperaturen	●	
Zentrale Überwachung		
8-Zoll-LCD	●	
Motordrehzahl oder Tageszähler/Beschleunigung	●	
Motorkühlmittel-Temperaturanzeige	●	
Max. Leistung	●	
Kriechgang/Schnellgang	●	
Automatischer Leerlauf	●	
Überlast	●	
Motor überprüfen	●	
Luftfilter verstopft	●	
Anzeigen	●	
ÖKO-Anzeigen	●	
Kraftstoffstandanzeige	●	
Anzeige für die Hydrauliköltemperatur	●	
Kraftstoffvorwärmer	●	
Warnungen	●	
Kommunikationsfehler	●	
Batterie niedrig	●	
Uhr	●	
Kabinenscheinwerfer	●	
Regenschutz für Kabinenfrontfenster	●	
Kabinendachabdeckung in Stahl		●
Sitz		
Einstellbarer Fahrersitz mit Luftfederung und Heizung		●
Kabinen-FOPS/FOG (ISO/DIN 10262) Stufe 2		
FOPS (Schutzeinrichtung gegen herabfallende Gegenstände) - ISO 3449 Stufe 2		●
FOG (Schutzaufbau gegen herabfallende Gegenstände)		●
Kabinen-ROPS (ISO 12117-2)		
ROPS (Überrollschutz)	●	

SICHERHEIT	STD	OPT
Batterie Hauptschalter	●	
Heckkamera	●	
Kameragestützte virtuelle Draufsicht incl. Bewegobjektüberwachung (AAVM + MOD)		●
Vier Arbeitsscheinwerfer	●	
Fahralarm	●	
Arbeitsscheinwerfer hinten	●	
Rundumleuchte		●
Automatische Schwenkbremse	●	
Auslegerhaltesystem	●	
Stielhaltesystem	●	
Sicherheitsventil für Auslegerzylinder mit Überlastwarneinrichtung	●	
Sicherheitsventil für Löffelstielzylinder		●
Drei Außenrückspiegel	●	
SONSTIGES		
Ausleger		
6,15 m; 20' 2"		●
6,45 m; 21' 2"	●	
Löffelstiel		
2,2 m; 7' 3"		●
2,5 m; 8' 2"		●
3,2 m; 10' 6"	●	
4,05 m; 13' 3"		●
Herausnehmbares Kühlerstaubgitter	●	
Herausnehmbarer Vorratsbehälter	●	
Kraftstoffvorfilter	●	
Kraftstoffvorwärmer		●
Selbstdiagnosesystem	●	
Hi-mate (Maschinenmanagementsystem)	●	
Batterien (2 x 12 V x 160 Ah)	●	
Kraftstoffbetankungspumpe (50 l/min)	●	
Einfach wirkende Verrohrung (Hydraulikhammer usw.)		●
Doppelt wirkende Verrohrung (Zweischalengreifer usw.)	●	
Verrohrung für drehende Anbaugeräte		●
Verrohrung für hydraulische Schnellwechsler		●
Schnellwechsler		●
Auslegerschwimmsteuerung		●
Einpedal-Geradeausfahrt		●
Druckspeicher beim Senken der Arbeitseinrichtung	●	
Bedienschema-Umschaltventil (2 Muster)		●
Werkzeugsatz		●
UNTERWAGEN		
Unterbodenschutz Unterwagen (extra)		●
Unterbodenschutz Unterwagen (normal)	●	
Bodenplatten		
3-Steg-Bodenplatten (600 mm; 24")	●	
3-Steg-Bodenplatten (700 mm; 28")		●
3-Steg-Bodenplatten (800 mm; 32")		●
3-Steg-Bodenplatten (900 mm; 36")		●
2-Steg-Bodenplatten (700 mm; 28")		●
Laufrollenschutz	●	
Laufrollenschutz "High Walker"		●

STD = Standard

OPT = Optional

* Standard- und Wahlausstattung können je nach Modell abweichen. Weitere Informationen erhalten Sie von Ihrem Hyundai-Händler. Die Maschinenausstattung kann von internationalen Normen abhängig sein.

* Auf den Fotos können Anbauten und optionale Geräte abgebildet sein, die in Ihrer Region nicht erhältlich sind. Änderungen der Materialien und technischen Daten vorbehalten.

* Alle Maße in angloamerikanischen Maßeinheiten sind auf das nächste volle Maß (Pound oder Zoll) gerundet.